

Chlorine-free wellness water thanks to HYDROZON® treatment

Basic information



Swimming pool wellness oasis

Nowadays, more is expected of a swimming pool than just being able to swim in it. A swimming pool is supposed to be a restful location in which you can quickly forget everyday stress. A place in which the mind and soul can find relaxation and the body can refuel on energy.

The central element in the pool is and will always be the water. Its quality is the decisive feel-good factor as it directly effects our senses. The water should be odourless, optically clear and gentle on the eyes. However, the largest organ of perception is the skin. Wellness water should therefore have a comfortable temperature, should not cause irritations and should feel fine and bubbly.

Water treatment for perfect water quality

Over the next few pages we will explain why water treatment is necessary, what has to be observed and what the individual parameters mean. This is where you will find your path to chlorine-free wellness water for the highest demands, using perfectly harmonised technology, with the major advantage of not having to deal with dangerous products during operation.

Everyone emits unwanted substances into the water when bathing. Even very thorough showering and washing cannot prevent this. This contamination includes sweat, skin particles and dandruff, microorganisms, bacteria and viruses (pathogens of transmitted diseases), organic substances, such as excretions from the mouth, throat, nose and ears, and even residual urine and faeces, blood from injuries, fungi, sunscreen products and skin creams etc.



When bathing in the bath tub, this does not represent a problem since the bathing water is generally only used by one person. However, in public baths it is common for up to several hundred people to bathe in the same water at the same time or successively. This pollutes the water heavily with unwanted substances. Therefore, for hygienic reasons and in order to avoid infections, bathing water has to be treated and disinfected continuously using appropriate measures.

Were one to attempt to clean water simply by „diluting“ it, vast amounts of fresh water and energy would be required. Therefore the water in swimming pools and baths is usually circulated using a water treatment system.

An important step in water treatment is the minimum content of disinfectant in the pool water. The role of the disinfectant is to sterilise the water in order to prevent the direct transmission of pathogens to other bathers reliably.

However, this process requires good water mixing and intensive pool flow. A good and even surface skimming is also important so that floating materials, such as hairs and mucous, are removed quickly from the pool (see „Pool hydraulics“).

Pool hydraulics A good pool flow is the basis for the even distribution of the disinfectant and reliable and quick removal of inactive microorganisms, contamination and pollutants. In the process, it is important for the entire volume flow to drain evenly over the edge of the pool in order to remove floating material and ensure a good water quality, in particular for the head area.

Water treatment cannot make up for insufficient pool hydraulics.

For this reason, specialist planners should be consulted accordingly, and the pool hydraulics - in particular for artificial designs - should be planned in detail.

Pool cleaning The water speed at the boundary areas of the wall and flow is almost zero. Insufficient water mixing, inadequate circulation or poor pool hydraulics can lead to zones with inadequate disinfectant content. Black joints and greasy wall surfaces are virtually guaranteed in these problem areas. Basic preventive, manual cleaning of the walls and the floor should therefore be carried out periodically. Underwater vacuum cleaners can be used to remove solid sediment (in particular in outdoor pools) completely.

Water treatment Treatment of swimming pool and bath water must not be limited to disinfection alone. Disinfection is more the final link in the process chain for ensuring hygiene in swimming pool water. The first step as part of the hygienisation process is flocculation filtration. The main role of the filter stage, alongside the retention of particles and turbidity, is to retain particle-bound carbon and largely eliminate the detached, organic carbon. An oxidation stage with ozone supports this process considerably. Functional flocculation with a subsequent filter stage is used both to remove the phosphate almost completely from the water, and reduce the consumption of disinfectant. Only drinking water must be used as fresh water for water replenishment and to offset rinsing water losses.

Sorption filter As well as the desired reactions of the disinfection, some unwanted disinfection by-products are also generated (DBP), in particular in case of heavy use or poor filling water quality. They can be broken down effectively and removed using a sorption filter (activated carbon filter) in a bypass (approximately 8-10 % of the circulation rate) - if required, in combination with a UV system.

Volume flow The volume flow is the calculated circulation of the water content in a certain time required for a properly operational swimming pool. This value - often referred to as the circulation volume flow or circulation rate - is based solely on the type of pool plus supplements for attractions installed in the pool. The circulation rate for public baths is determined as per the specifications of DIN 19643-1.

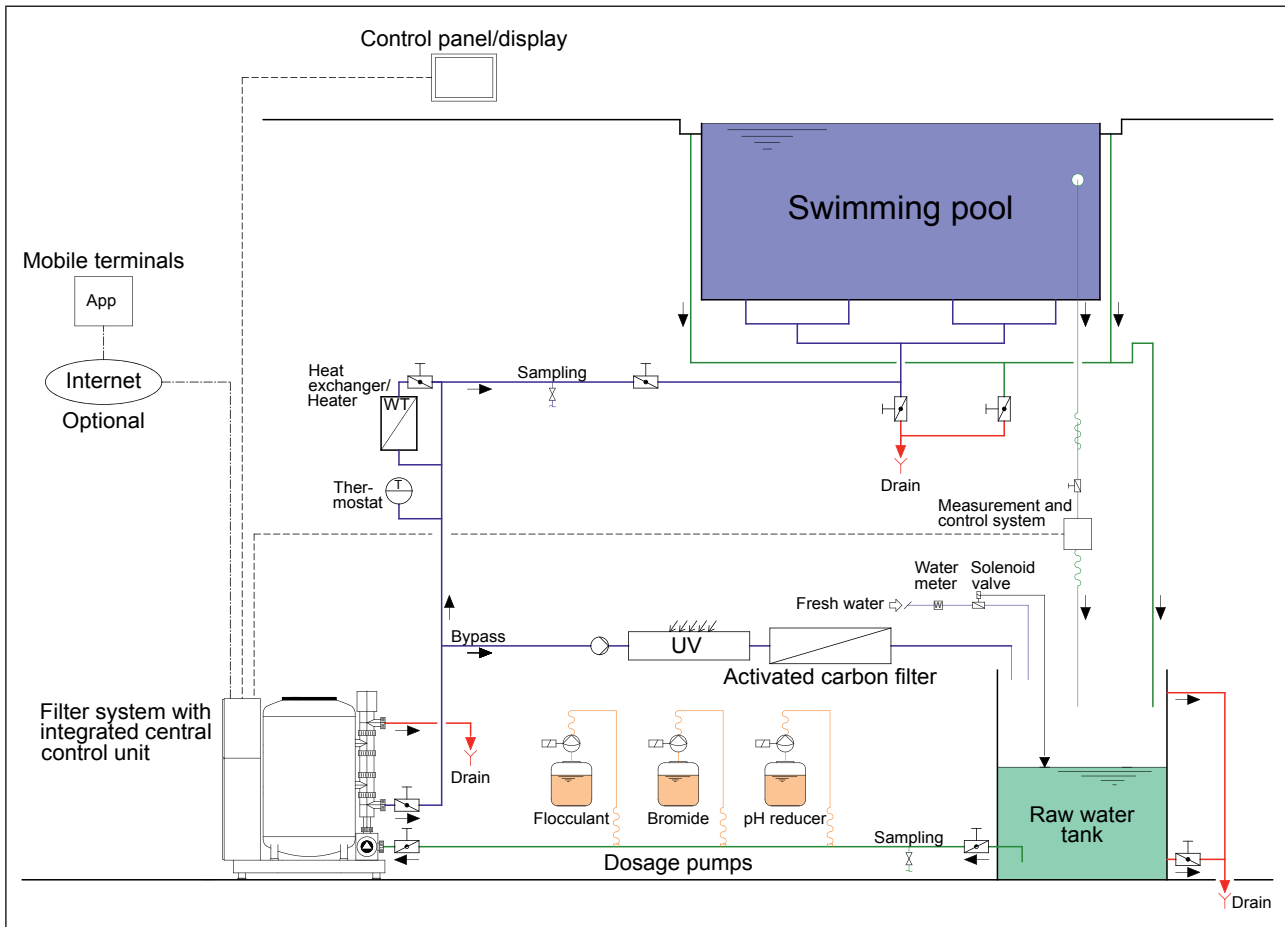

Diagram Treatment cycle when using HYDROZON®-Kompaktanlagen compact systems.

Nominal capacity The nominal capacity is defined as the total permissible number of people in the pool in an hour. This value is determined when the pool is designed.

The nominal capacity is a calculated value which takes into account the type of pool, the pool size of the pool and the frequency of use. The nominal capacity of public baths is determined as per the empirically obtained data provided in DIN 19643-1.

Flocculation filtration Flocculants are iron or aluminium salt-based inorganic electrolytes. Flocculants offset (= destabilise) electric charges on the surfaces of solids. This causes the formation of micro-flakes and macro-flakes which in turn form larger agglomerates and are held back by the filter. The flocculation filtration cleans the water above all by removing corpuscular particles and colloiddally dissolved substances.

Functional flocculation precipitates phosphate and optimises the filtrate quality. It is important to note that the flocculation is a process which depends on the pH value, and the pH value and the acid capacity have to be maintained within the range specified for the flocculant.

Acid capacity The higher the hardness in water, the more stably the water performs when using additives with alkaline or acidic properties. In other words: As long as there are sufficient hydrogencarbonate ions in the water, the pH value is also stable. Flocculants are strongly acidic due to hydrolysis, and can thus affect the pH value. Therefore flocculants with a higher alkalinity (>65 %) have to be preferred for lower acid capacities (0.3 - 0.7 mmol/l) (see also „pH value“).

The acid capacity is a treatment parameter which is ultimately intended to ensure that the treatment capacity is not compromised by insufficient flocculation as a result of an excessively low buffer capacity. This is the case as long as there are no conspicuous pH value fluctuations and no heightened aluminium content in the pool water.

The acid capacity is not a value which is relevant to health. An acid capacity in the range of >0.3 mmol is fully sufficient for the HYDROZON® method.

Disinfection Disinfection is the inactivation of unwanted microorganisms. In the case of water disinfection the inactivation is performed by eliminating the oxygen atom bound to the hypochlorous or hypobromous acid which penetrates into the cell structure and thus irreparably damages, i.e. ends, its vital process. The disinfectant thus also has a carrier function. This is also the case with the chlorination of chlorine gas. As a result of the autoprotolysis (dissolution with proton transfer) of the chlorine, hydrochlorous and hydrochloric acid is produced after the chlorination process. In the process, the hydrochloric acid causes a pH value reduction which has to be compensated for again.

The hydrochlorous or hypobromous acids are the actual effective substances for disinfection. It is important to note that the autoprotolysis is an equilibrium reaction which depends on the pH value. In the range of pH = 6.5 to 8, which is relevant to pool water, the content of effective disinfection constantly drops as the pH value increases, whilst the content of disinfectant hypochlorite/hypobromite increases (see „pH value“). Therefore, in order to maintain the disinfection capacity, the total disinfectant content has to be clearly increased as the pH value increases.

In the case of bromine this effect is much less than with chlorine. With a pH of 7.5 with bromine, for instance, there is still around 94 % of effective hypobromous acid. In the case of chlorine there is only 50 % of hydrochlorous acid. In the typical pH range for bromine pools of 6.8 to 7.2 there is almost exclusively strongly disinfectant hypobromous acid.

Disinfectants Disinfectants containing chlorine, bromine and iodine are used in a broad range of areas in everyday use. The effective mechanisms of the three halogens and their links to disinfection are largely identical and well known. Disinfectants also have an oxidising effect and thus cause the formation of unwanted by-products, in particular in conjunction with organic water substances (see „Sorption filter“).

The disinfectant contents are measured as free bromine or free chlorine and generally are in a range of 0.8 to 1.2 mg/l (bromine) and 0.35 to 0.55 mg/l (chlorine) respectively. In whirlpools values roughly twice as high are required. With integrated ozone stages the values can be lower, within a range of 0.4 to 1 mg/l (bromine) or 0.2 to 0.5 mg/l (chlorine).

pH value The pH value is the critical parameter for both flocculation and disinfection. The formation of unwanted disinfectant by-products, such as bromate, can be minimised by a beneficial pH value. The pH value therefore has to be measured continuously and kept within the specified range by batching agents which regulate the pH value.

Many substances hydrolyse in water, and the generated acids disassociate. During hydrolysis (also autoprotolysis) a hydrogen atom is emitted onto a substance component, the residual hydroxide reacts with the other substance components.

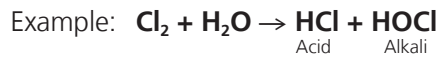

The hydrolysis can be regarded in a simplified manner as the opposite of neutralisation. In the next step the generated acid disassociates.

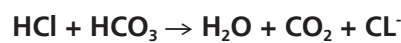

Aluminium-based flocculants work ideally in the pH value range of 6.8 - 7.2. Flocculants have an acidic effect, i.e. they lower the pH value. Therefore, in order to keep the pH value in the pool water stable, a minimum value for the acid capacity has to be observed:

For flocculants with an alkalinity $\leq 65\%$ the minimum value is $\geq 0,7$ mmol/l,
 for flocculants with an alkalinity $> 65\%$ the acid capacity should not drop below 0,3 mmol/l.

The following graphs show the pH value-related distribution of the balanced substances carbon, hydrochloric acid and hypobromous acid.

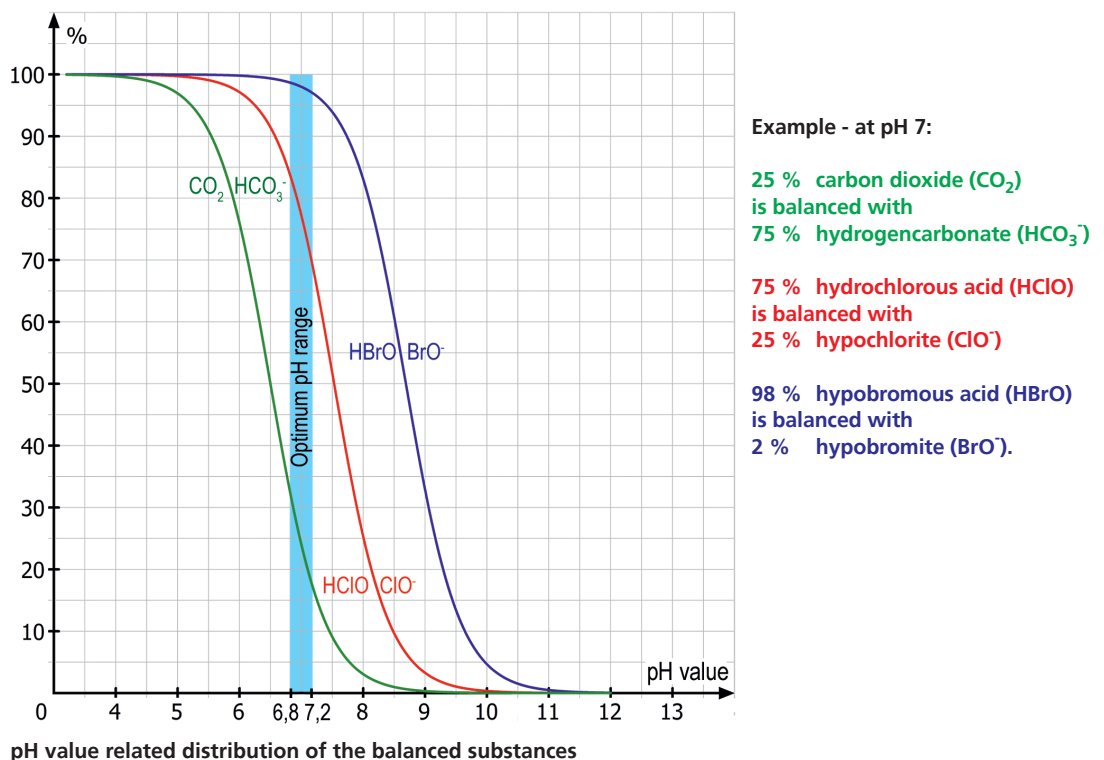

At higher temperatures there are slight shifts towards somewhat lower pH values.

Oxidation Oxidation is the process in which elements or compounds are combined with oxygen. The oxidising substance emits electrons which are in turn transferred to the oxidising agent. Ozone is regarded as an excellent oxidation agent in the field of water treatment. Ozone is activated oxygen with a high specific oxidation potential (2.07 V). Ozone is both an excellent oxidation agent and a disinfectant. For this reason, medical therapy pools with a high infection risk in particular need to be equipped with ozone stages. The ozonation also mineralises the reaction products produced by the reaction of the disinfectant with urea.

Ozone Thanks to its high oxidation potential, ozone causes organic and inorganic water contamination to oxidise very rapidly.

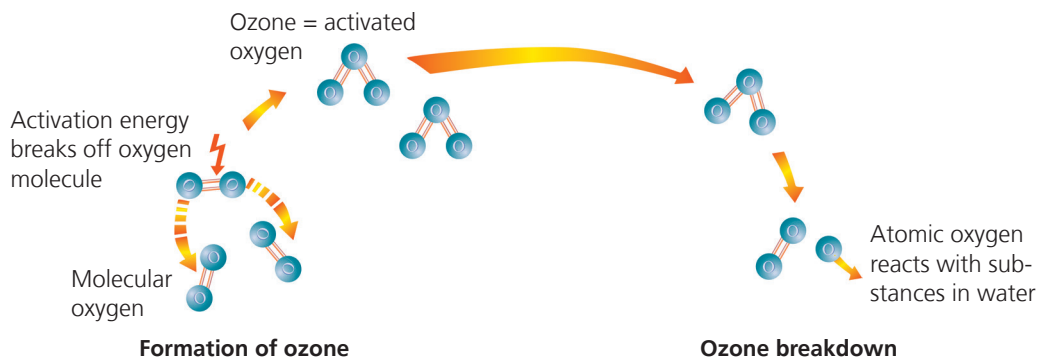

Ozone is not stable and therefore has to be generated using special ozone generators at the location of use. Atmospheric oxygen and electrical energy are required for the generation of ozone. Nowadays, ozone is generated almost exclusively using oxygen. This prevents the formation of unwanted nitrogen oxides. The oxygen is generated by local concentration. Modern ozone generators work extremely efficiently with plasma technology. They can be adjusted continuously variably within a broad power range.

Auxiliary hygiene parameters The pool water cannot be monitored constantly for any possible microorganisms. Auxiliary hygiene parameters have been introduced in order to make information on the pool water quality available nonetheless. If they are adhered to at all times, it can be assumed that the pool water will be sufficiently disinfected and safe.

An essential parameter is the **free bromine** (usually measures as free chlorine) which - depending on the pool type - should be within a range of 0.5 to 1.5 mg/l (max. 2.0 mg/l).

Practical values are in the range from 0.8 to 1.2 mg/l (see also „Disinfectant“). Further auxiliary hygiene parameters are the **pH value**, the **redox potential** and the **oxidisability** and **TOC/DOC**.

The HYDROZON® method is pH value neutral. **Practical values are in the range from 6.8 to 7.2**. The value to aim for is 7.0.

- Redox potential (ORP)** The redox potential (ORP) is the most important cumulative hygiene parameter. It is a dimension for the ratio of reductive substances and the oxidising substances. The redox potential for bromide pools (bromide >10 mg/l) should not drop below 700 mV. The minimum value for chlorine pools is 750 mV. The redox potential, an excellent quality parameter, provides information on the current contamination of the pool water and the effectiveness of the disinfectant measured as free bromine. A high redox potential with a low content of disinfectant indicates a high disinfection efficiency and low water contamination. Inversely, a high disinfectant content with a low redox potential indicates heavy contamination.
- With HYDROZON® method there is a direct correlation between the generated quantity of ozone, the free bromine and the redox potential. Due to the independence from the pH value, smaller pools/private pools can therefore also be equipped with redox control.
- Bound bromine** The chloramines referred to as bound chlorine are responsible for the typical smell of an indoor pool and also bind disinfectant.
- The HYDROZON® method does not produce any chloramines but rather largely odourless bromamines, which also have a disinfectant effect.
- Chloramines and bromamines are produced when there is nitrogen content in filling waters, and in case of water contamination or insufficient filter performance. Sorption filters can have a minimising effect in this case.
- Oxidisability** When determining the oxidisability of the pool water, its bromide content has to be taken into account. This is generally performed by mathematically correcting the measured values. The reason is the formation of bromine as a result of the reaction of bromide with potassium permanganate. The spectral absorption coefficient (SAC at 254 nm) and the total organic carbon (TOC) are superior control parameters for testing the effectiveness of water treatment for waters with bromide content.
- Bromide content** In order for the HYDROZON® method to function properly, a certain minimum quantity of bromide ions in the water is required.
- For stoichiometric purposes, a few g/m³ of water would be sufficient. In order to ensure permanently that no ozone can enter into the pool water, a minimum bromide content of 20 g/m³ should be maintained. The bromide ion content is set by adding sodium bromide salt in solid or liquid form.
- When filling a pool for the first time or when refilling, a bromide content of 15 g/m³ is achieved by adding 1 kg of HYDRO-BROMID „kristallin“ salt for each 50 m³ of pool content. Whilst operation is in progress, only dilution and other losses (e.g. backflushing, rain water etc.) caused as a result of filling water replenishment have to be offset. Bromide is replenished either by regularly adding aqueous sodium bromide solution (HYDRO-BROMID „flüssig“) or combined with BROMOFLOC® flocculant.
- The salt consumption for the average private pool is approximately only 1 kg per year.

Chlorine-free wellness water with the HYDROZON® method

Advantages High-performance HYDROZON® compact filter systems, operating based on the decades-old, tried-and-tested HYDROZON® method, produce swimming pool water without chlorine, or rather chlorine-free wellness water, in the ideal manner. The perfectly harmonised system technology of the fully automatic stainless steel filter systems makes for permanently perfect water quality for the highest demands.

HYDROZON® method The method is based on the oxidation reaction of ozone with bromide ions.

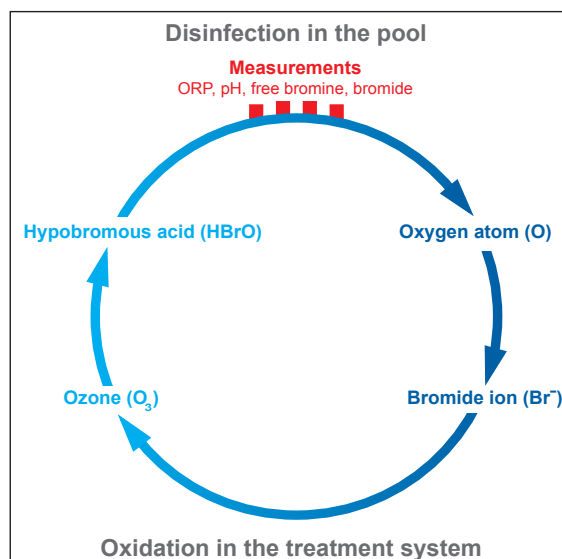

Sodium bromide (NaBr) is a natural salt. It is present in all sea water with contents of up to 60 mg/l. Much thermal water also contains significant quantities of bromide.

When bromide reacts with the unstable ozone, ozone breaks down to an oxygen molecule whilst the oxygen atom oxidises with bromide to form hypobromite, which hydrolyses and disassociates to form hypobromous acid. Hypobromous acid is an excellent odourless disinfectant.

HYDROZON® compact systems With the HYDROZON® method the ozone is mixed with water within the closed hydraulic system. Ozone is generated in the ozone generator from oxygen with the aid of electrical energy. The bromide is added to the pool water as sodium bromide salt (HYDRO-BROMID „kristallin“), in an aqueous solution or with BROMOFLOC® flocculant (see „Bromide content“).

The water is disinfected and oxidised in the **reaction chamber**. Simultaneously, excess ozone reacts with **bromide ions** and generates the disinfectant **hypobromous acid or hypobromite**. Disinfection in the pool area is performed as a result of the separation of the **oxygen atom** from the effective disinfectant.



After disinfection in the pool area the bromide ion is available again for reaction with ozone. Bromide is thus kept in circulation constantly.

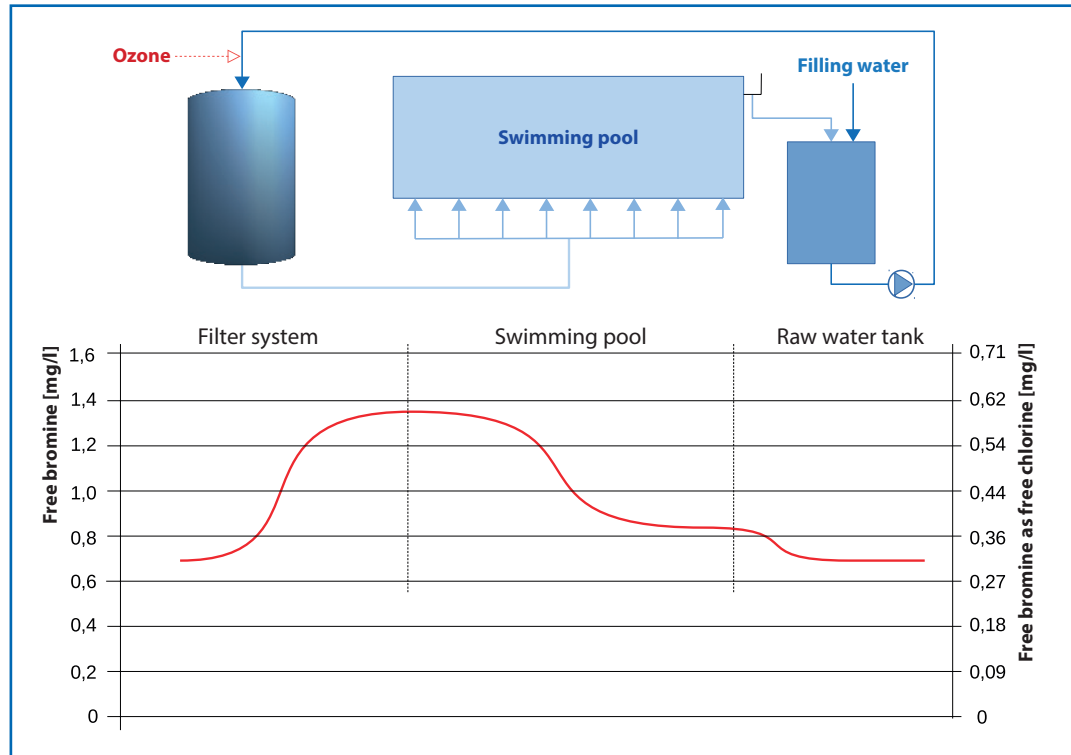

Verlauf des Desinfektionsmittelgehaltes im Beckenwasserkreislauf beim Ozon-Brom-Verfahren

A particular benefit is that the disinfectant is formed upstream of the filter, and thus flows through the complete filter. As a result, filter contamination with legionella or pseudomonas practically never occurs.

Wellness water with HYDROZON®-system technology

The highly functional compact filter systems contain all the necessary components. The integrated ozone stage makes for excellent oxidation and disinfection of the water. The resultant pleasant, low-odour, oxygen-rich and bubbly wellness water turns any pool into a wellness oasis with optically crystal-clear water. It is particularly suitable for people with sensitive skin. The method produces pH-neutral disinfectant within the closed treatment circulation system, resulting in minimised chemical consumption.

Contact Consultation/sales services provided exclusively by our specialist premium partners.

